

CHAPTER 12: SECONDARY- STORAGE SYSTEMS

Chapter 12: Mass-Storage Systems

- Overview of Mass-Storage Structure
- Disk Structure
- Disk Attachment
- Disk Scheduling
- Disk Management
- Swap-Space Management
- RAID Structure
- Stable-Storage Implementation
- Tertiary-Storage Structure

Objectives

- Describe the physical structure of secondary and tertiary storage devices and the resulting effects on the uses of the devices

- Explain the performance characteristics of mass-storage devices

- Discuss operating-system services provided for mass storage, including:
 - RAID (Redudant Arrays of Inexpensive Disks)
 - HSM (Hierarchical Storage Management)
 -

Overview of Mass-Storage Structure

- Magnetic disks provide bulk of secondary storage of modern computers
 - Drives rotate at 60 to 200 times per second (3600~12000rpm)
 - **Transfer rate**
 - the rate at which data flow between drive and computer
 - **Positioning time (random-access time)**
 - time to move the disk arm to desired cylinder (**seek time**) and time for the desired sector to rotate under the disk head (**rotational latency**)
 - **Head crash** results from disk head making contact with the disk surface

Overview of Mass-Storage Structure

- Disks can be removable

- Drive attached to computer via **I/O bus**
 - ▣ Buses vary, including
 - **EIDE(Enhanced Integrated Drive Electronics)**
 - **SATA(Serial Advanced Technology Attachment)**
 - **USB(Universal Serial Bus)**
 - **SCSI(Small Computer System Interface)**
 - **etc.**

 - ▣ **Host controller** in computer uses bus to talk to **disk controller** built into drive or storage array

Moving-head Disk Mechanism

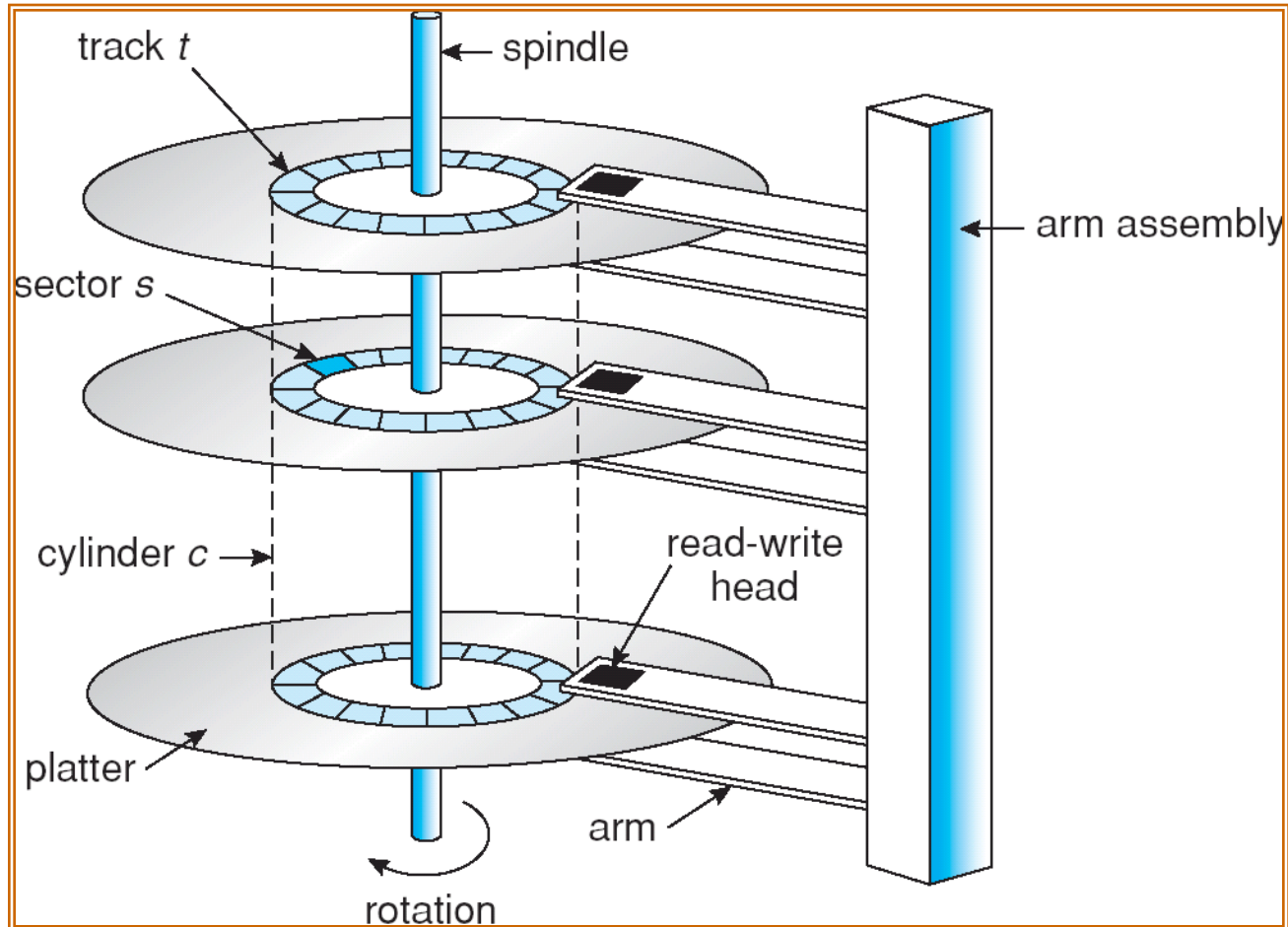

Overview of Mass Storage Structure (Cont.)

□ Magnetic tape

- Was early secondary-storage medium
- Relatively permanent and holds large quantities of data
- Access time slow
- Random access ~1000 times slower than disk
- Mainly used for backup, storage of infrequently-used data, transfer medium between systems
- Kept in spool and wound or rewound past read-write head
- Once data under head, transfer rates comparable to disk
- 20-200GB typical storage
- Common technologies are 4mm, 8mm, 19mm, LTO-2 and SDLT

Disk Structure

- Disk drives are addressed as large 1-dimensional arrays of *logical blocks*.
 - ▣ the logical block is the smallest unit of transfer.
- The 1-dimensional array of logical blocks is mapped into the sectors of the disk sequentially.
 - ▣ Sector 0 is the first sector of the first track on the outermost cylinder.
 - ▣ Mapping proceeds in order through that track, then the rest of the tracks in that cylinder, and then through the rest of the cylinders from outermost to innermost.

Disk Attachment

- Host-attached storage accessed through I/O ports talking to I/O busses
- SCSI itself is a bus, up to 16 devices on one cable, **SCSI initiator** requests operation and **SCSI targets** perform tasks

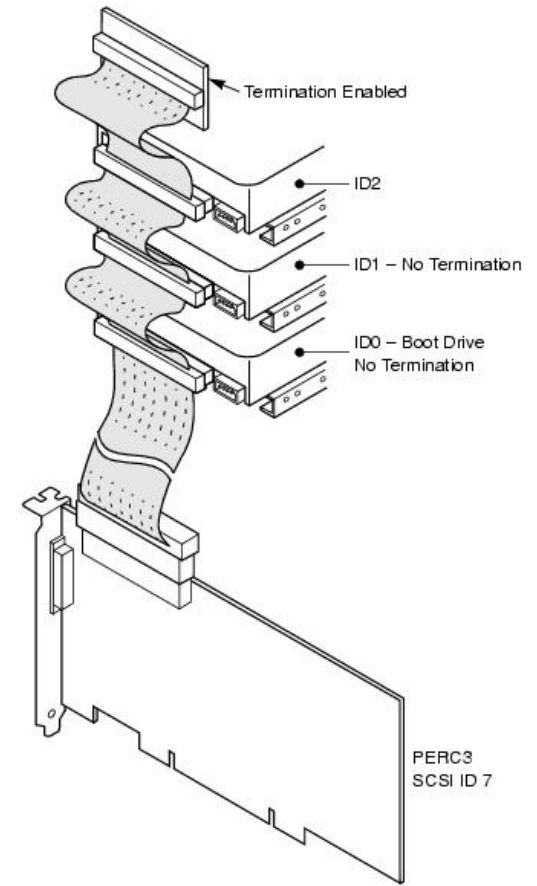
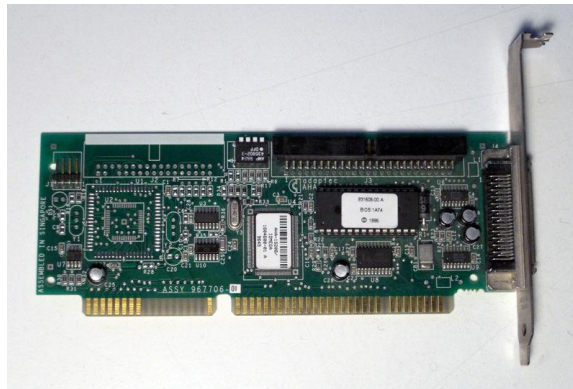

Disk Attachment

- Fiber channel (FC) is high-speed serial architecture
 - ▣ Can be switched fabric with 24-bit address space – the basis of **storage area networks (SANs)** in which many hosts attach to many storage units



Fiber

<http://www.electronicsshowplace.com>

Network-Attached Storage

- Network-attached storage (**NAS**) is storage made available over a network rather than over a local connection (such as a bus)
- NFS(Network File System) in UNIX systems and CIFS(Common Internet file system) for Windows are common protocols
- Implemented via remote procedure calls (RPCs) between host and storage

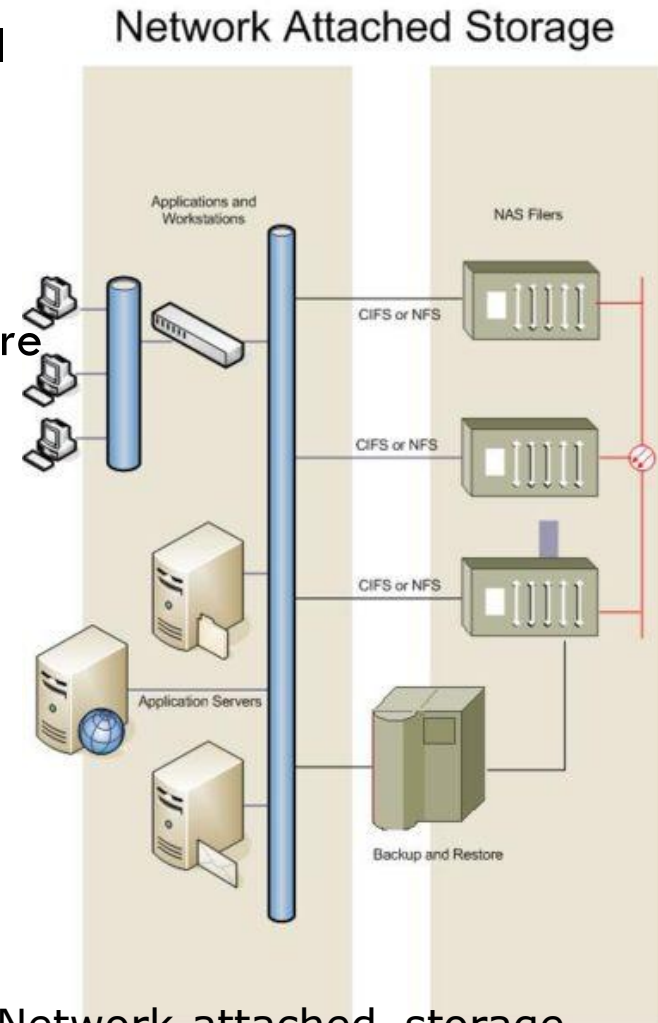
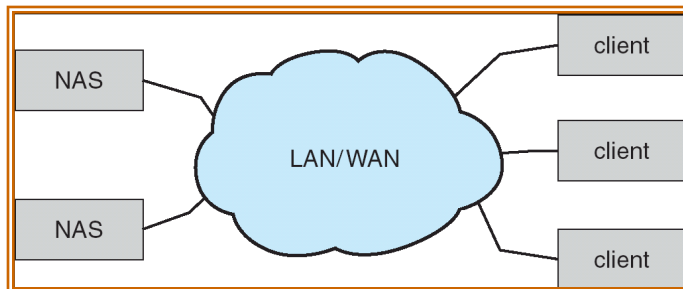

Storage-Area Network

- Network specifically dedicated to the task of transporting data for storage and retrieval
- Common in large storage environments (and becoming more common)
- Multiple hosts attached to multiple storage arrays - flexible

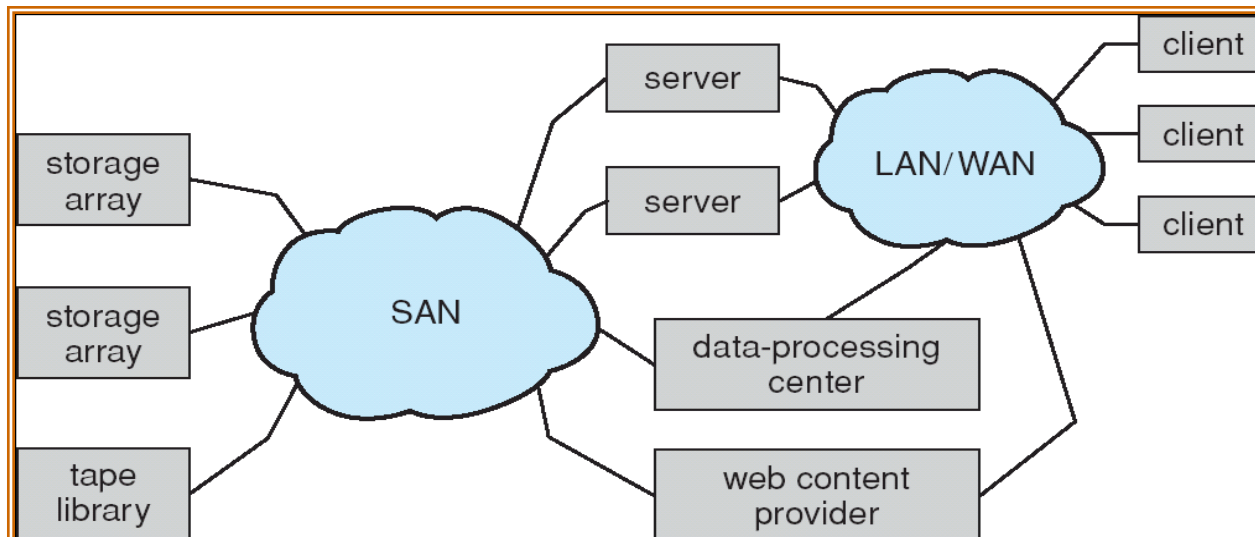

Disk Scheduling

- The operating system is responsible for using hardware efficiently
 - for the disk drives, this means having a fast access time and disk bandwidth.

- Access time has two major components
 - *Seek time*
 - the time for the disk are to move the heads to the cylinder containing the desired sector.
 - *Rotational latency*
 - the additional time waiting for the disk to rotate the desired sector to the disk head.

Disk Scheduling (Cont.)

- Minimize seek time
- Seek time \approx seek distance
- Disk bandwidth
 - the total number of bytes transferred, divided by the total time between the first request for service and the completion of the last transfer.

Disk Scheduling (Cont.)

- Several algorithms exist to schedule the servicing of disk I/O requests.
- We illustrate them with a request queue (0-199).

98, 183, 37, 122, 14, 124, 65, 67

Head pointer 53

FCFS Disk Scheduling

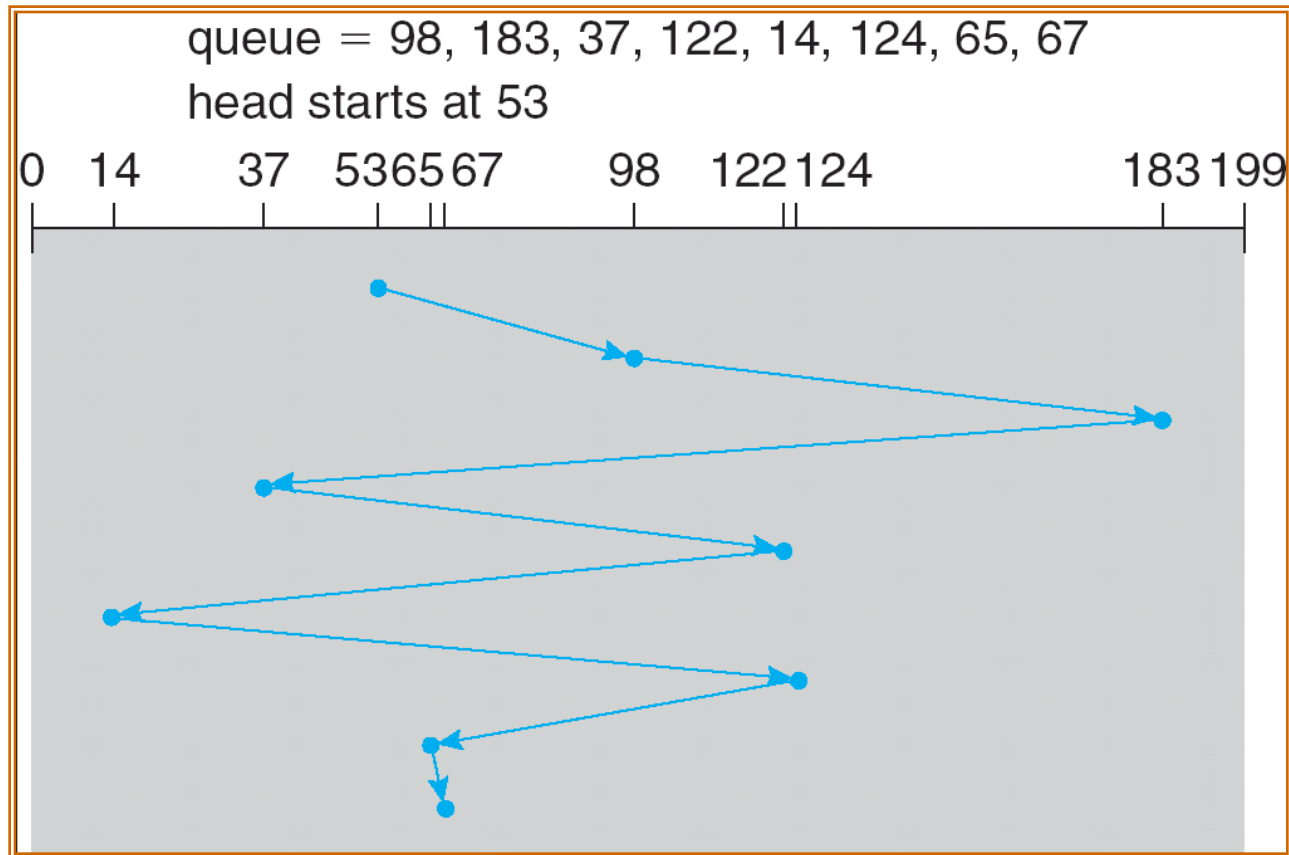
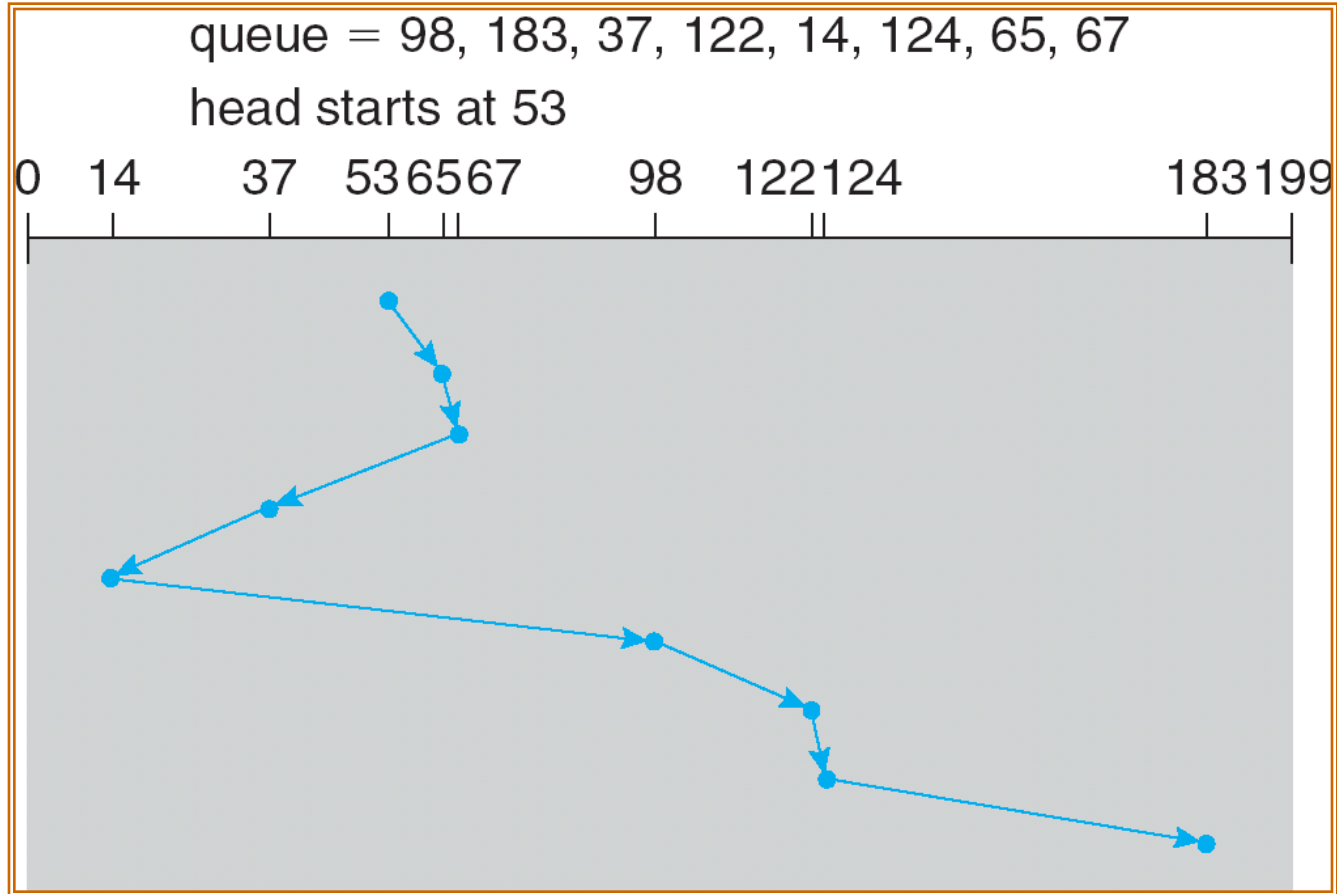

Illustration shows total head movement of 640 cylinders.

SSTF Scheduling

- Selects the request with the minimum seek time from the current head position.
- Shortest seek time first scheduling
 - ▣ a form of SJF scheduling
 - ▣ may cause starvation of some requests.

SSTF Disk Scheduling



- Illustration shows total head movement of 236 cylinders.

Is it an optimal solution?

SCAN Scheduling

- The disk arm starts at one end of the disk, and moves toward the other end, servicing requests until it gets to the other end of the disk, where the head movement is reversed and servicing continues.
- Sometimes called the *elevator algorithm*.

SCAN Disk Scheduling

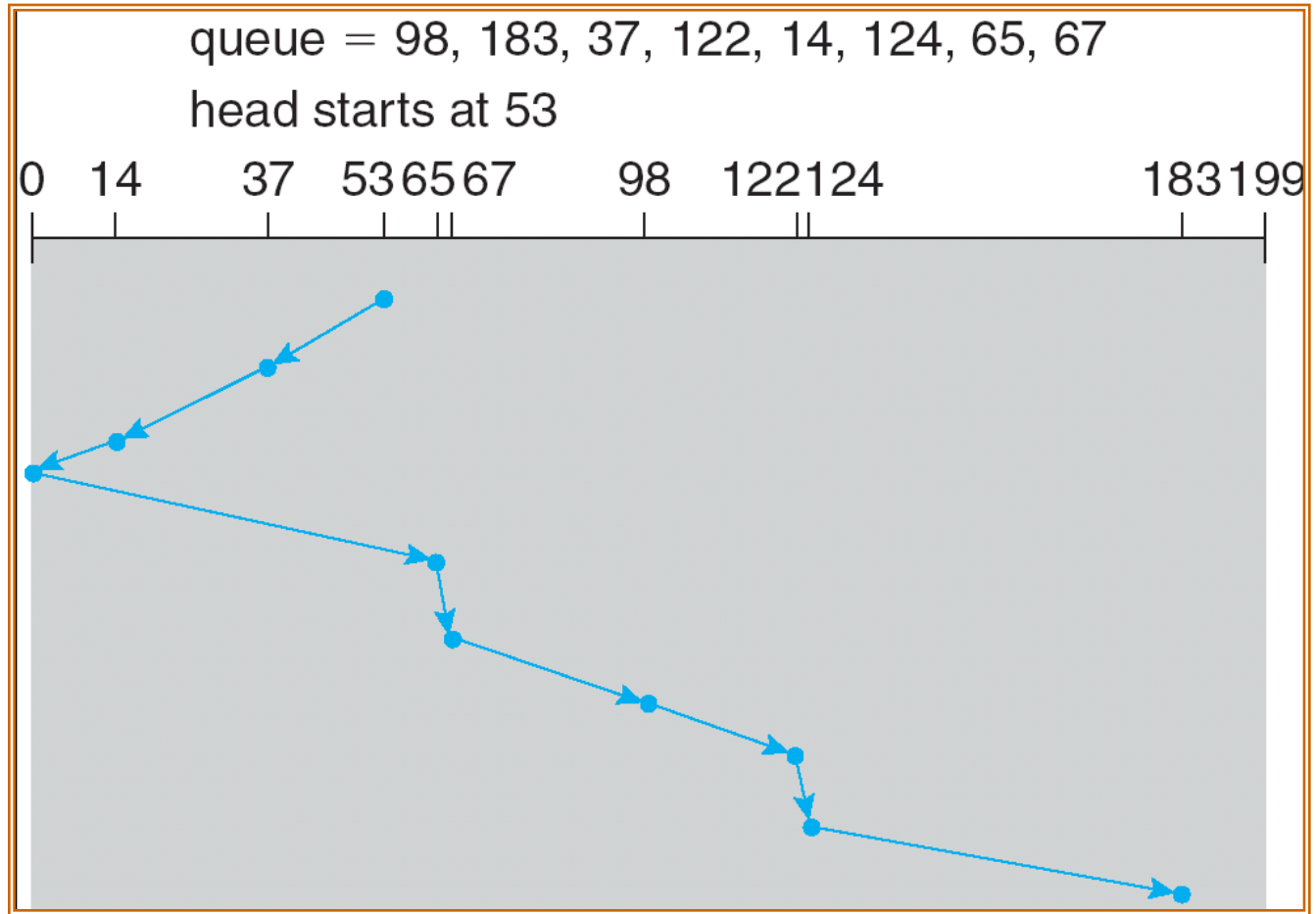
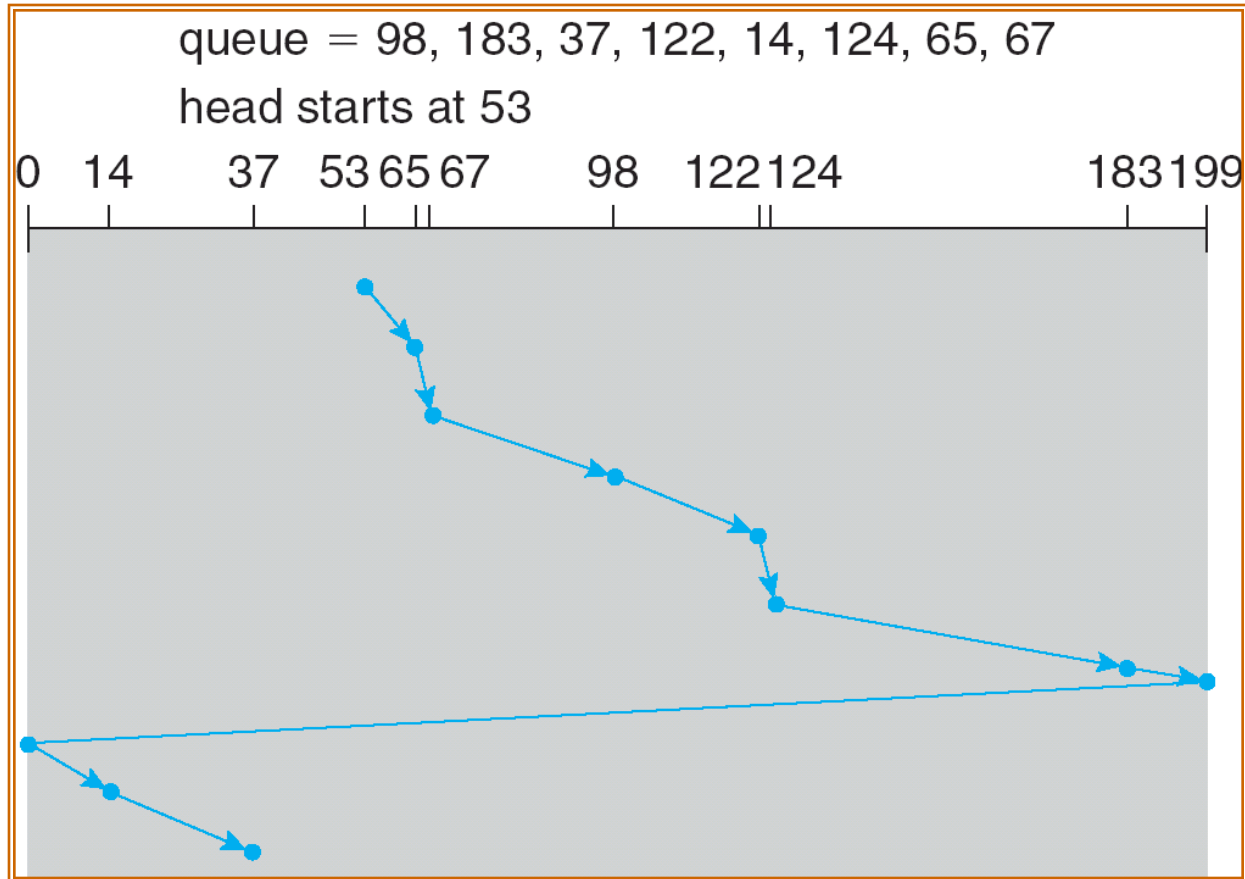

Illustration shows total head movement of 236 cylinders.

C-SCAN Scheduling

- The head moves from one end of the disk to the other, servicing requests as it goes. When it reaches the other end, however, it immediately returns to the beginning of the disk, without servicing any requests on the return trip.
- Treats the cylinders as a circular list that wraps around from the last cylinder to the first one.
- Provides a *more uniform wait time* than SCAN.

C-SCAN Disk Scheduling



total head movement of 382 cylinders.

C-LOOK

- Version of C-SCAN
- Arm only goes as far as the last request in each direction, then reverses direction immediately, without first going all the way to the end of the disk.

C-LOOK DISK Scheduling

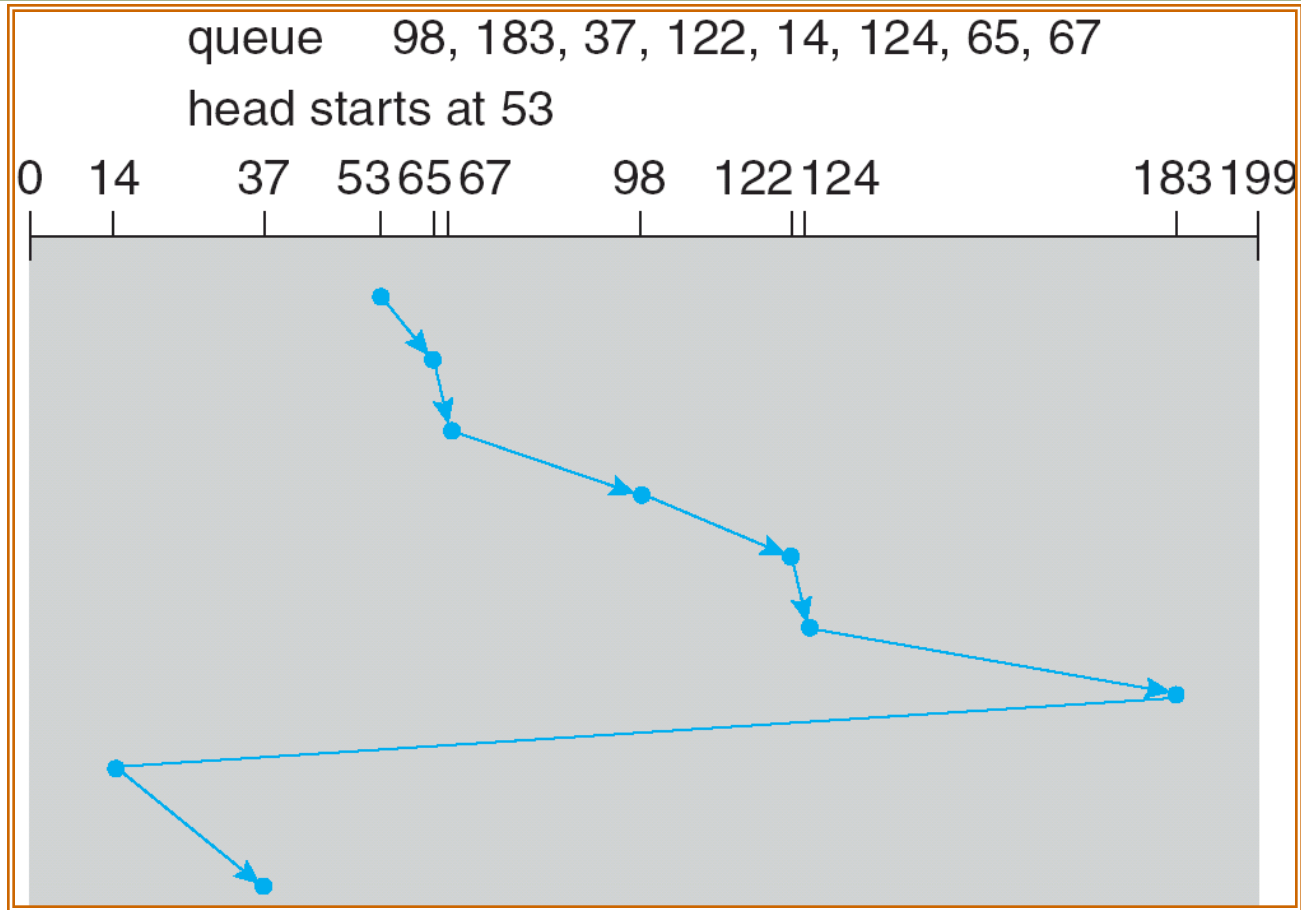

total head movement of 322 cylinders.

Selection of a Disk-Scheduling Algorithm

- SSTF is common and has a natural appeal.
- SCAN and C-SCAN perform better for systems that place a heavy load on the disk.
- Performance depends on the number and types of requests.
- Requests for disk service can be influenced by the file-allocation method.

Selection of a Disk-Scheduling Algorithm (cont.)

- The disk-scheduling algorithm should be written as a separate module of the operating system, allowing it to be replaced with a different algorithm if necessary.
- Either SSTF or LOOK is a reasonable choice for the default algorithm.

Disk Management

- *Low-level formatting, or physical formatting* — Dividing a disk into sectors that the disk controller can read and write.
- To use a disk to hold files, the operating system still needs to record its own data structures on the disk.
 - *Partition* the disk into one or more groups of cylinders.
 - *Logical formatting* or “making a file system”.
- **Boot block initializes system.**
 - The bootstrap is stored in ROM.
 - *Bootstrap loader* program.
- Methods such as *sector sparing* used to handle bad blocks.

Booting from Disk in Windows 2000

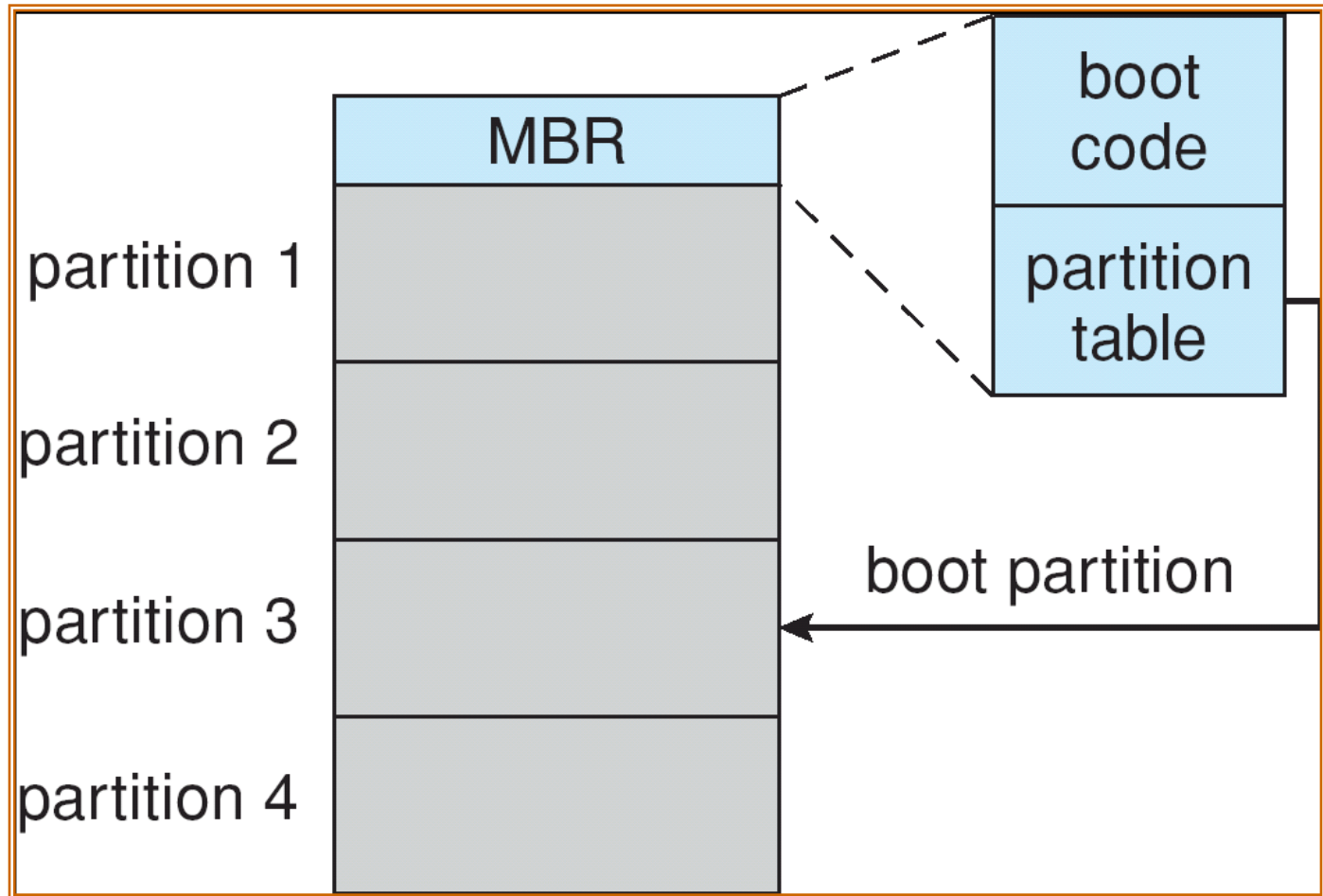

Swap-Space Management

- Swap-space — Virtual memory uses disk space as an extension of main memory.
- Swap-space can be carved out of the normal file system, or, more commonly, it can be in a separate disk partition.
- Swap-space management
 - 4.3BSD allocates swap space when process starts; holds *text segment* (the program) and *data segment*.
 - Kernel uses *swap maps* to track swap-space use.
 - Solaris 2 allocates swap space only when a page is forced out of physical memory, not when the virtual memory page is first created.

The Data Structures for Swapping on Linux Systems

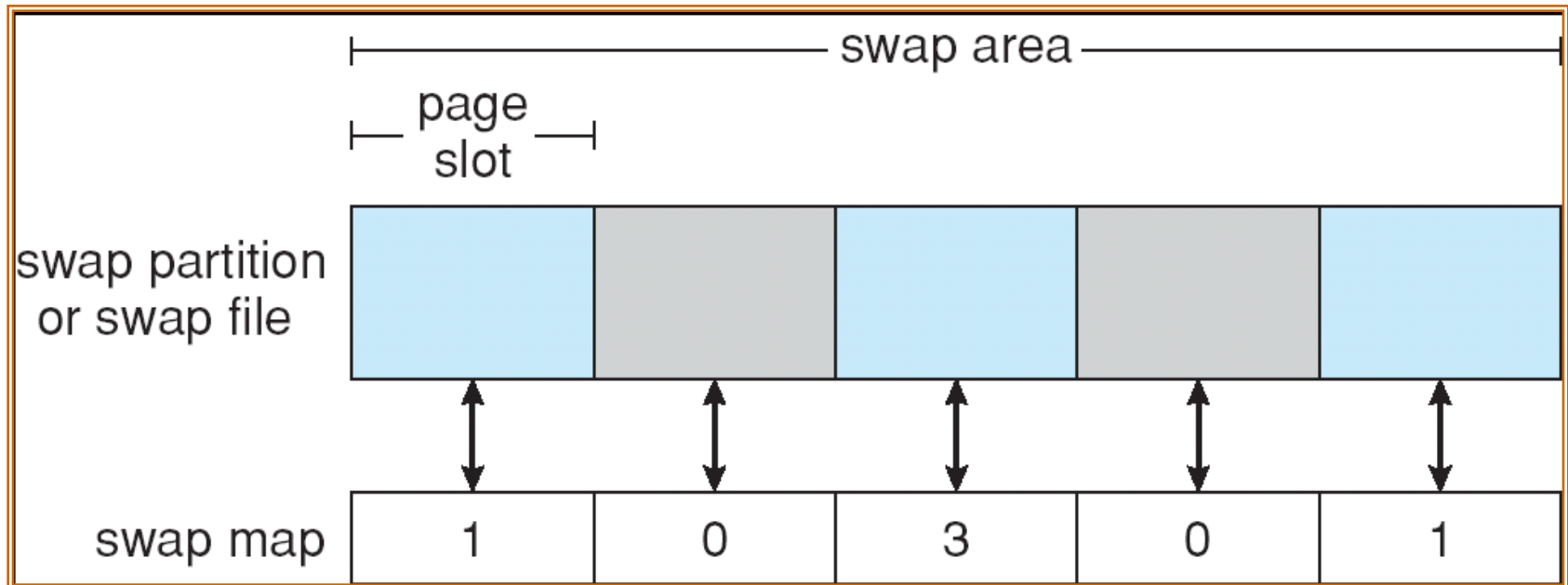

RAID Structure

- **RAID**
 - Redundant Arrays of Inexpensive Disks (or Redundant Array of Independent Disks)
 - multiple disk drives provides **reliability** via **redundancy**.
- RAID is arranged into six different levels.

RAID (cont.)

- Several improvements in disk-use techniques involve the use of multiple disks working cooperatively.
- Disk striping uses a group of disks as one storage unit.
- RAID schemes improve performance and improve the reliability of the storage system by storing redundant data.
 - *Mirroring* keeps duplicate of each disk.
 - *Block interleaved parity* uses much less redundancy.

RAID Levels



(a) RAID 0: non-redundant striping.



(b) RAID 1: mirrored disks.



(c) RAID 2: memory-style error-correcting codes.



(d) RAID 3: bit-interleaved parity.



(e) RAID 4: block-interleaved parity.



(f) RAID 5: block-interleaved distributed parity.



(g) RAID 6: P + Q redundancy.

RAID 0 (non-redundant striping)

CPUからABCDというデータの書き込み指示

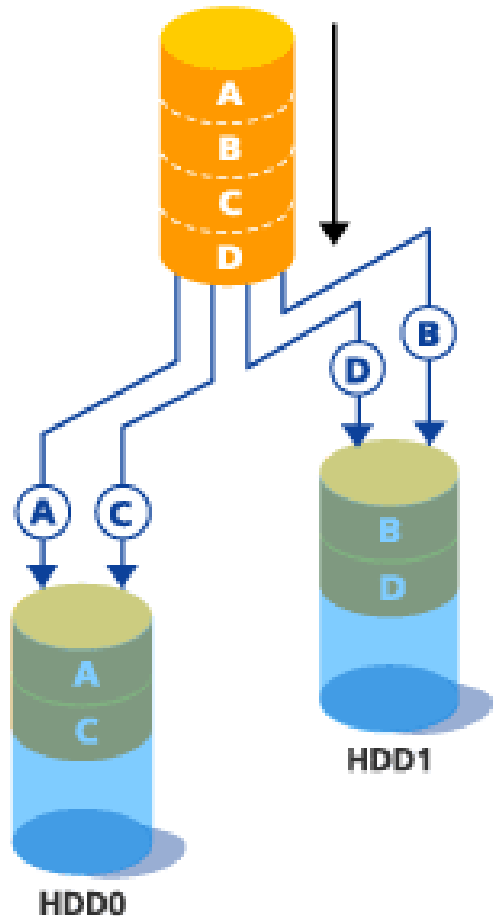

複数ディスクへ分散して書き込む
ストライピング処理を行う

Striped set without parity.

- Performance improves
- Problems when disk fails

figure from
[storage-system.fujitsu.com/ jp/term/raid](http://storage-system.fujitsu.com/jp/term/raid)

RAID 1 (mirrored disks)

CPUからABCDというデータの書き込み指示

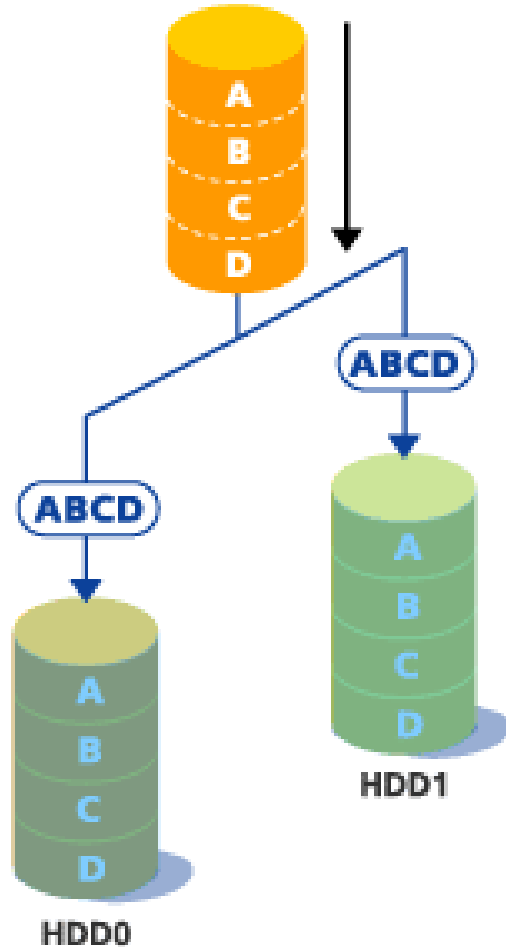

データを2台のディスクに同時に書き込む

Mirrored set without parity.

- Provides fault tolerance from disk errors

figure from
[storage-system.fujitsu.com/ jp/term/raid](http://storage-system.fujitsu.com/jp/term/raid)

RAID 3 (bit interleaved striping)

CPUからABCDというデータの書き込み指示

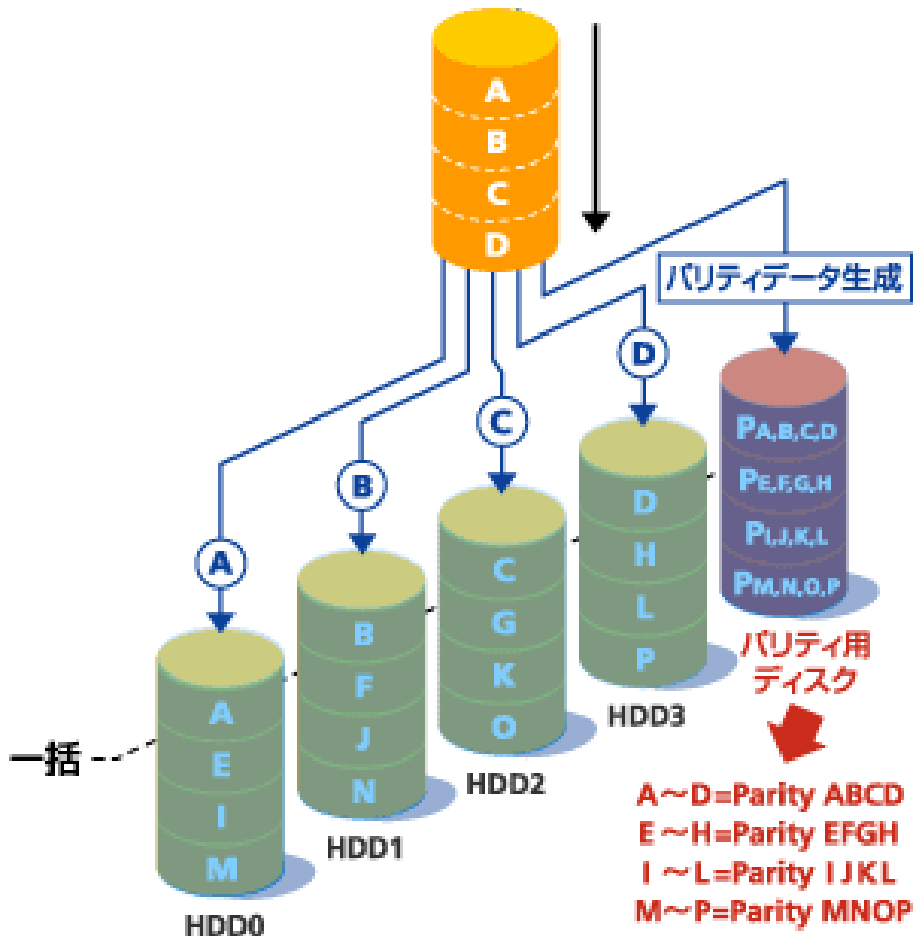

ストライプ幅(上図ではABCD)を常に一括アクセスすることが保証されているため、高速転送を実現

Striped set with dedicated parity

- bottle-neck : parity disk

figure from [storage-system.fujitsu.com/ jp/term/raid](http://storage-system.fujitsu.com/jp/term/raid)

RAID 4 (block-interleaved parity)

CPUからABCDというデータの書き込み指示

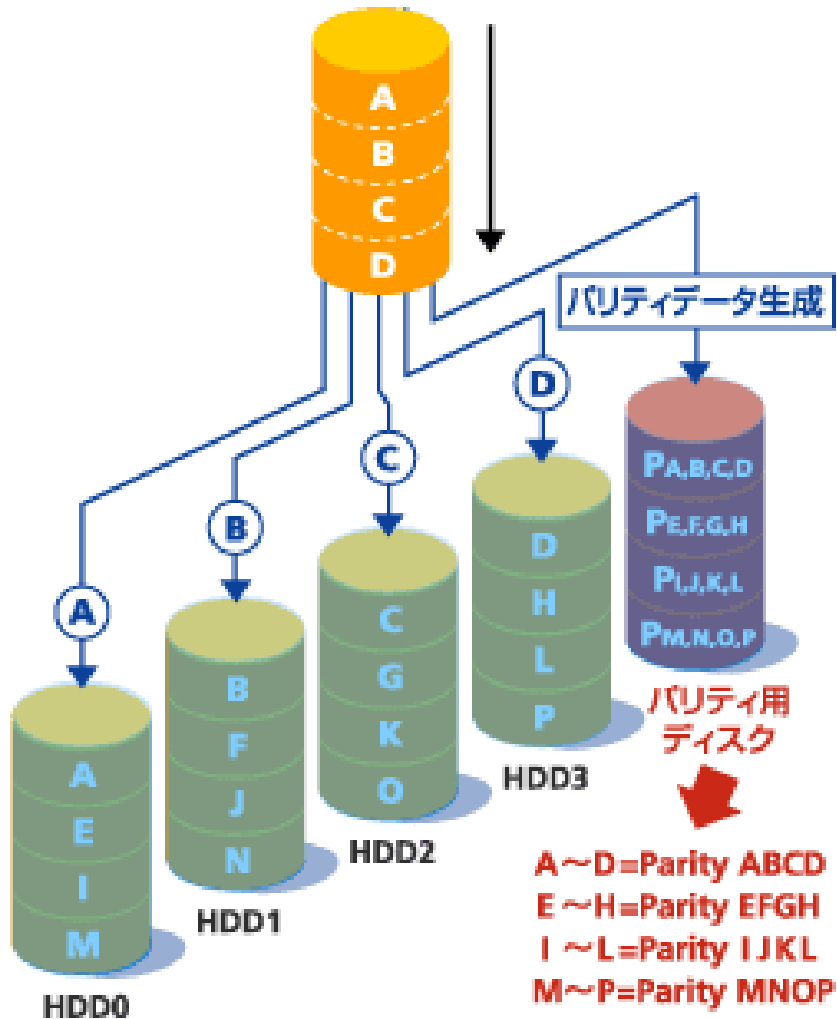

minimum of 3 disks

figure from storage-system.fujitsu.com/jp/term/raid

RAID 5 (block-interleaved distributed parity)

CPUからABCDというデータの書き込み指示

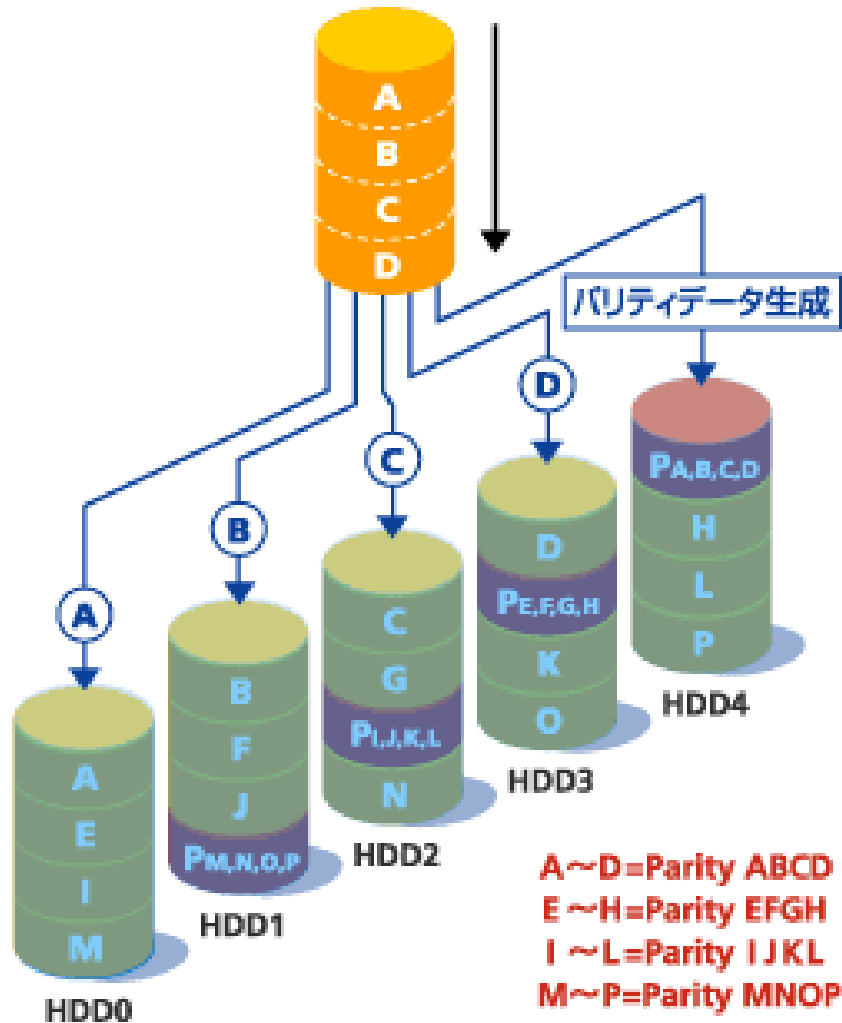
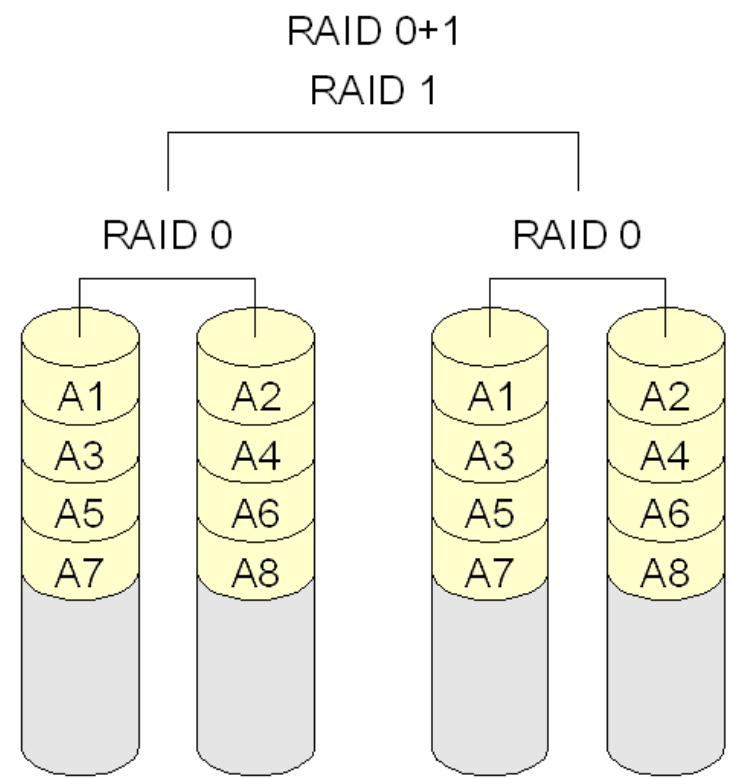
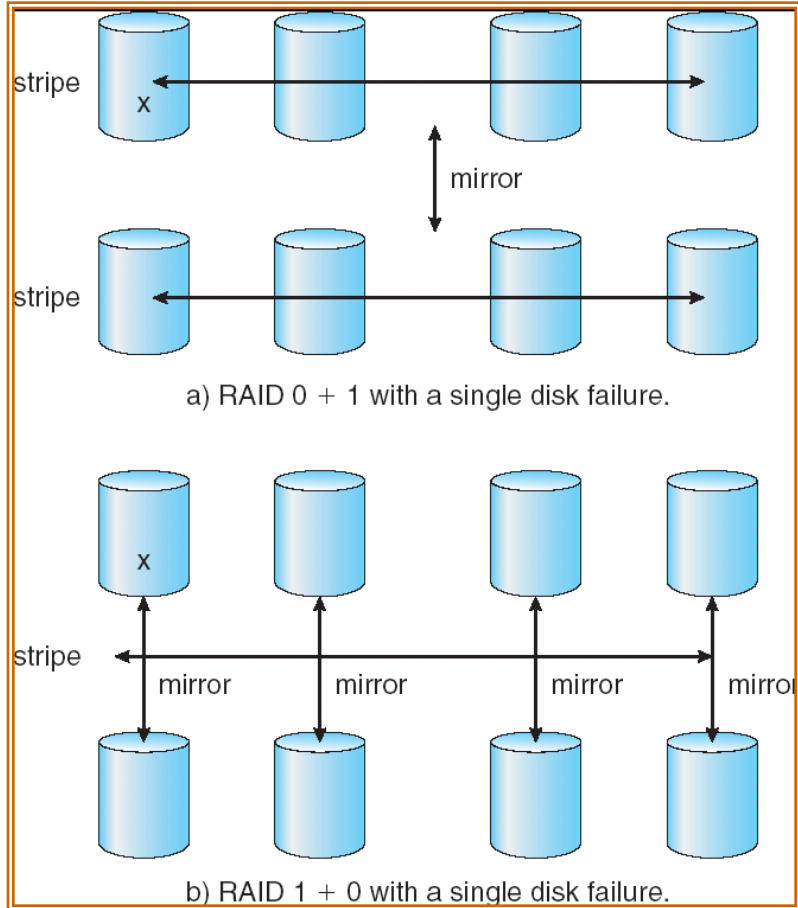

figure from storage-system.fujitsu.com/jp/term/raid

RAID 0 + 1 and 1 + 0



RAID 0 + 1 and 1 + 0

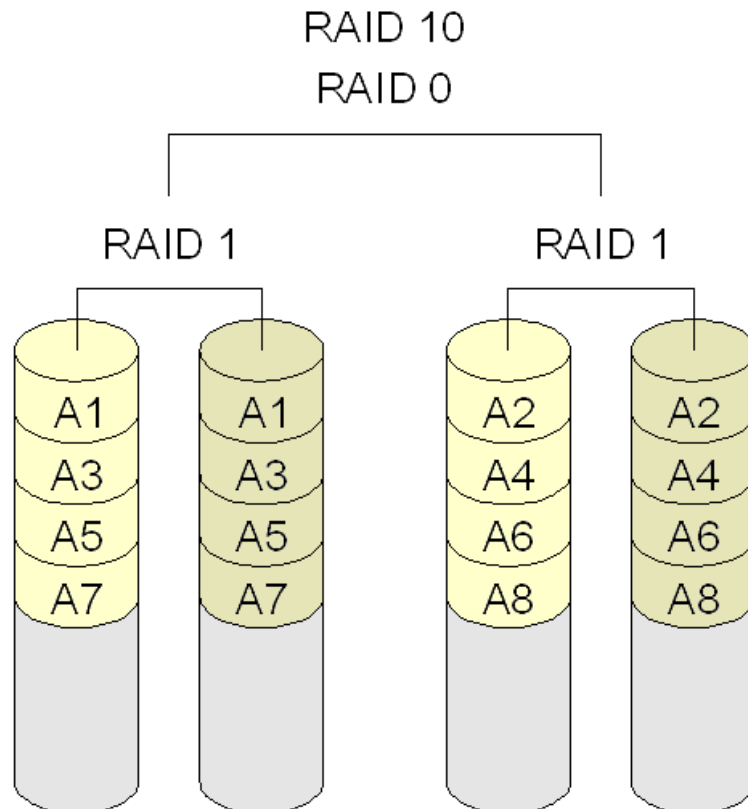

Figure from logout.hu/iras/a_raid-rol_kezdoknek_3.html

Stable-Storage Implementation

- Write-ahead log scheme requires stable storage.
- To implement stable storage:
 - Replicate information on more than one nonvolatile storage media with independent failure modes.
 - Update information in a controlled manner to ensure that we can recover the stable data after any failure during data transfer or recovery.

Tertiary-Storage Structure

- Low cost is the defining characteristic of tertiary storage.
- Generally, tertiary storage is built using *removable media*
- Common examples of removable media are floppy disks and CD-ROMs; other types are available.

Removable Disks

- Floppy disk — thin flexible disk coated with magnetic material, enclosed in a protective plastic case.
 - Most floppies hold about 1 MB; similar technology is used for removable disks that hold more than 1 GB.
 - Removable magnetic disks can be nearly as fast as hard disks, but they are at a greater risk of damage from exposure.

Removable Disks (Cont.)

- A magneto-optic disk records data on a rigid platter coated with magnetic material.
 - Laser heat is used to amplify a large, weak magnetic field to record a bit.
 - Laser light is also used to read data (Kerr effect).
 - The magneto-optic head flies much farther from the disk surface than a magnetic disk head, and the magnetic material is covered with a protective layer of plastic or glass; resistant to head crashes.
- Optical disks do not use magnetism; they employ special materials that are altered by laser light.

Tapes

- Compared to a disk, a tape is less expensive and holds more data, but random access is much slower.
- Tape is an economical medium for purposes that do not require fast random access, e.g., backup copies of disk data, holding huge volumes of data.
- Large tape installations typically use robotic tape changers that move tapes between tape drives and storage slots in a tape library.
 - ▣ stacker – library that holds a few tapes
 - ▣ silo – library that holds thousands of tapes
- A disk-resident file can be *archived* to tape for low cost storage; the computer can *stage* it back into disk storage for active use.

Operating-System Support

- Major OS jobs are to manage physical devices and to present a virtual machine abstraction to applications
- For hard disks, the OS provides two abstractions:
 - ▣ Raw device – an array of data blocks.
 - ▣ File system – the OS queues and schedules the interleaved requests from several applications.

Application Interface

- Most OSs handle removable disks almost exactly like fixed disks — a new cartridge is formatted and an empty file system is generated on the disk.
- Tapes are presented as a raw storage medium, i.e., and application does not open a file on the tape, it opens the whole tape drive as a raw device.
- Usually the tape drive is reserved for the exclusive use of that application.

Application Interface (cont.)

- Since the OS does not provide file system services, the application must decide how to use the array of blocks.
- Since every application makes up its own rules for how to organize a tape, a tape full of data can generally only be used by the program that created it.

File Naming

- The issue of naming files on removable media is especially difficult when we want to write data on a removable cartridge on one computer, and then use the cartridge in another computer.
- Contemporary OSs generally leave the name space problem unsolved for removable media, and depend on applications and users to figure out how to access and interpret the data.
- Some kinds of removable media (e.g., CDs) are so well standardized that all computers use them the same way.

Hierarchical Storage Management

- A hierarchical storage system extends the storage hierarchy beyond primary memory and secondary storage to incorporate tertiary storage — usually implemented as a jukebox of tapes or removable disks.
- Usually incorporate tertiary storage by extending the file system.
 - ▣ Small and frequently used files remain on disk.
 - ▣ Large, old, inactive files are archived to the jukebox.
- HSM is usually found in supercomputing centers and other large installations that have enormous volumes of data.

Speed

- Two aspects of speed in tertiary storage are bandwidth and latency.

- Bandwidth is measured in bytes per second.
 - Sustained bandwidth – average data rate during a large transfer; # of bytes/transfer time.
Data rate when the data stream is actually flowing.

 - Effective bandwidth – average over the entire I/O time, including **seek** or **locate**, and cartridge switching.
Drive's overall data rate.

Speed (Cont.)

- Access latency – amount of time needed to locate data.
 - Access time for a disk – move the arm to the selected cylinder and wait for the rotational latency; < 35 milliseconds.
 - Access on tape requires winding the tape reels until the selected block reaches the tape head; tens or hundreds of seconds.
 - Generally say that random access within a tape cartridge is about a thousand times slower than random access on disk.

Speed (Cont.)

- The low cost of tertiary storage is a result of having many cheap cartridges share a few expensive drives.
- A removable library is best devoted to the storage of infrequently used data, because the library can only satisfy a relatively small number of I/O requests per hour.

Reliability

- A fixed disk drive is likely to be more reliable than a removable disk or tape drive.
- An optical cartridge is likely to be more reliable than a magnetic disk or tape.
- A head crash in a fixed hard disk generally destroys the data, whereas the failure of a tape drive or optical disk drive often leaves the data cartridge unharmed.

Cost

- Main memory is much more expensive than disk storage
- The cost per megabyte of hard disk storage is competitive with magnetic tape if only one tape is used per drive.
- The cheapest tape drives and the cheapest disk drives have had about the same storage capacity over the years.
- Tertiary storage gives a cost savings only when the number of cartridges is considerably larger than the number of drives.

Price per Megabyte of DRAM, From 1981 to 2004

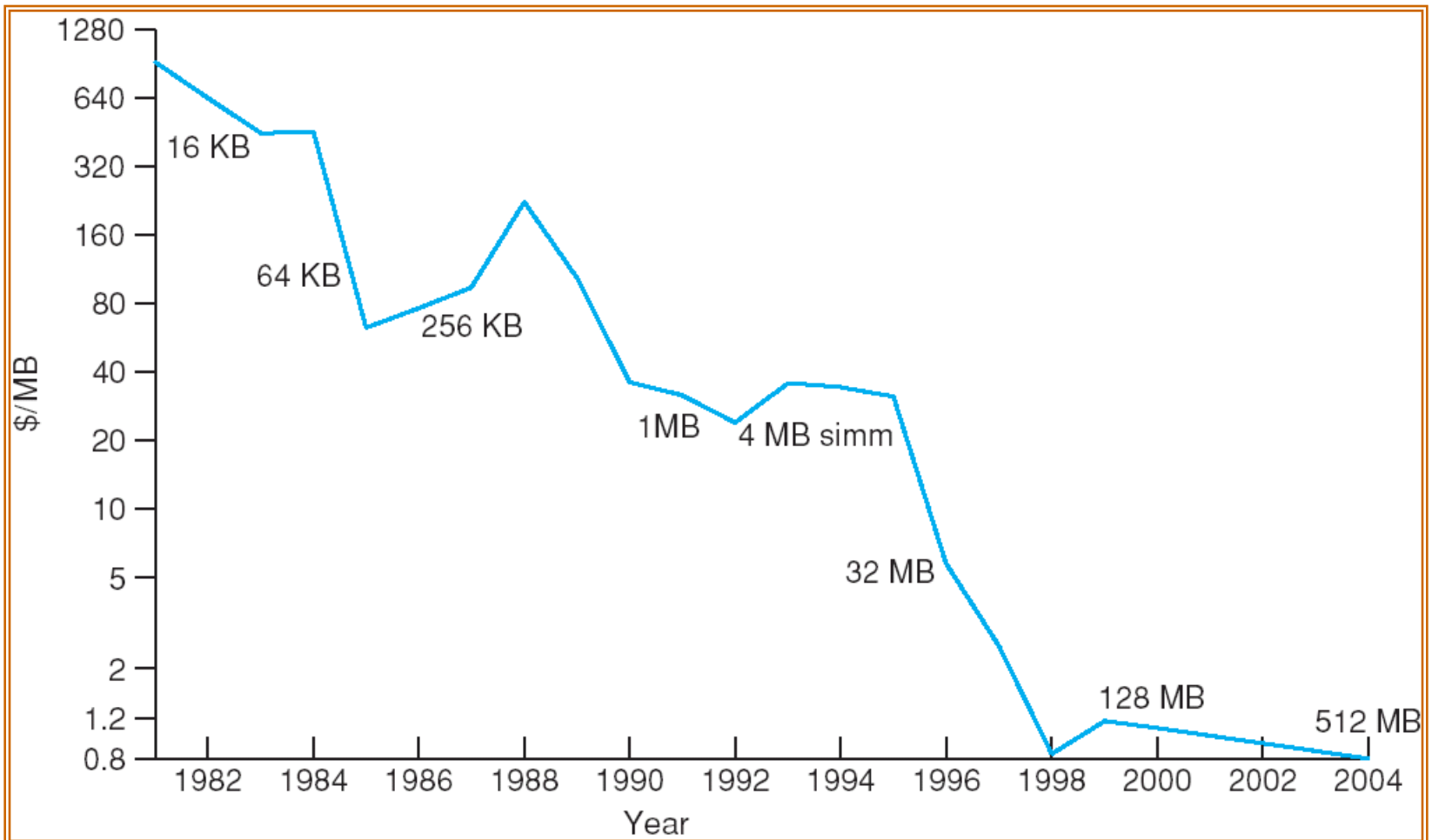

Price per Megabyte of Magnetic Hard Disk, From 1981 to 2004

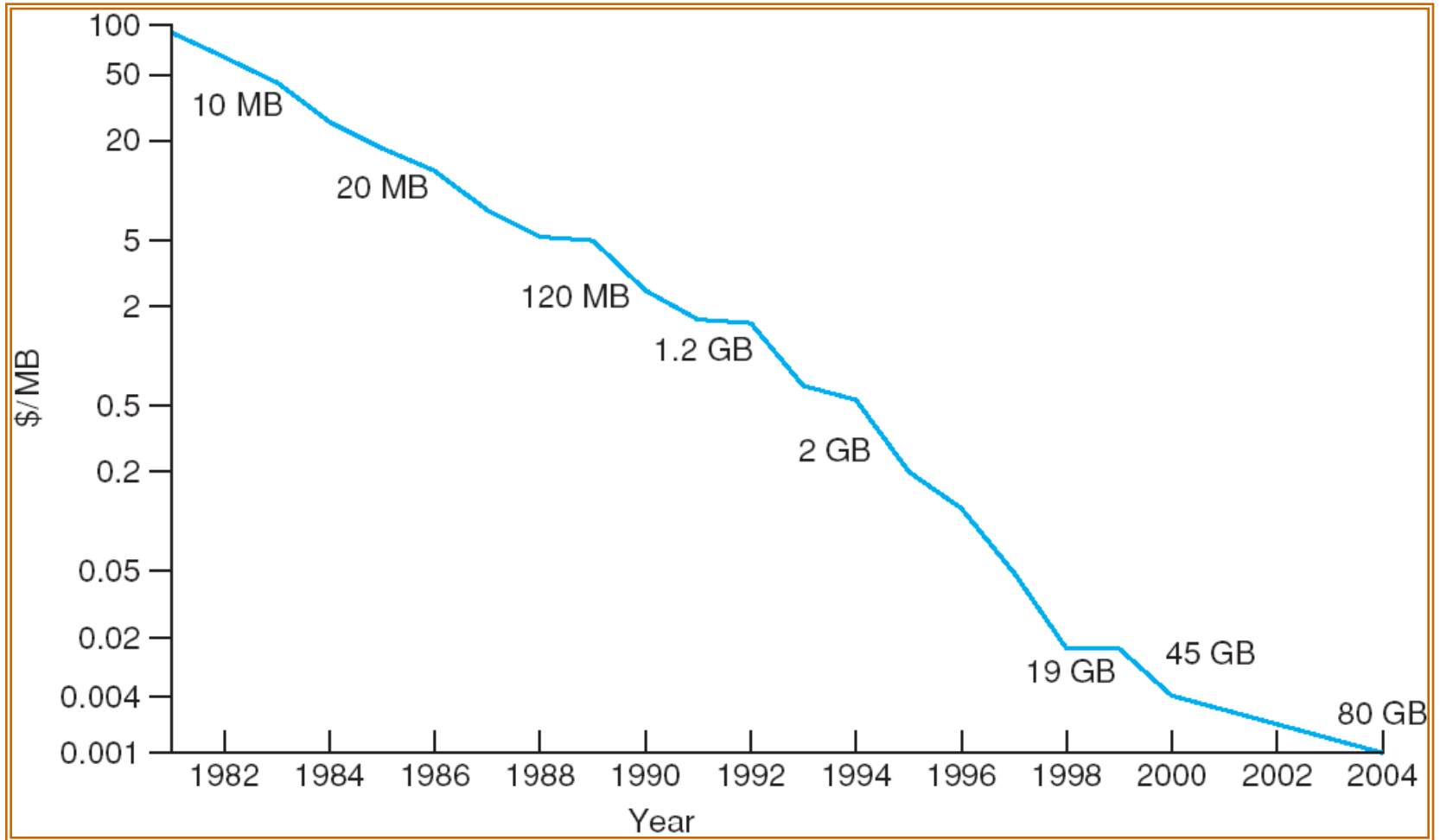

Price per Megabyte of a Tape Drive, From 1984-2000

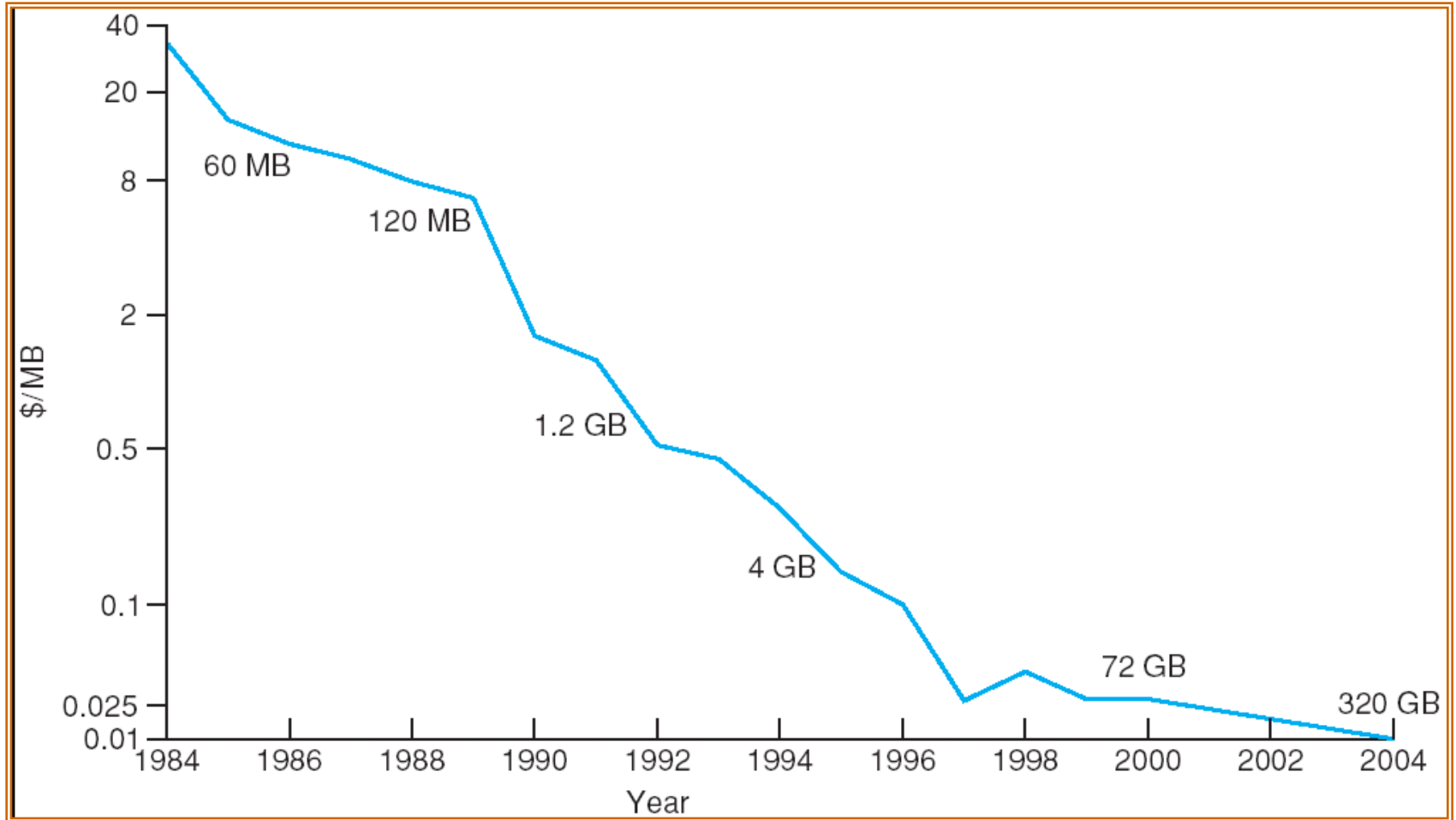

END OF CHAPTER 12